

# DATA SHEET

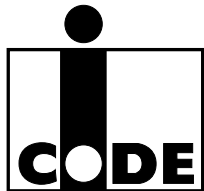

## **SL1ICS3101** **I-CODE1 Label IC (97 pF)**

Product specification  
Supersedes data of 2000 Jul 01

2002 May 23

**I-CODE1 Label IC (97 pF)****SL1ICS3101**

<b>CONTENTS</b>		
1	FEATURES	14
2	APPLICATIONS	14.1
3	GENERAL DESCRIPTION	14.2
4	ORDERING INFORMATION	14.3
5	BLOCK DIAGRAM	14.3.1
6	PINNING	14.3.2
7	FUNCTIONAL DESCRIPTION	14.3.3
7.1	General	15
7.2	Memory organization	16
7.2.1	Serial number	17
7.2.2	Write access conditions	18
7.2.3	Special functions	
7.2.4	Family code and application identifier	
7.2.5	User data	
8	LIMITING VALUES	
9	QUALITY ASSURANCE	
9.1	Electrical acceptance test	
9.2	Visual inspection	
9.2.1	After wafer final test	
9.2.2	After sawing (film frame carrier)	
10	HANDLING INSTRUCTIONS	
11	ELECTRICAL CHARACTERISTICS	
12	MECHANICAL CHARACTERISTICS	
12.1	Die specifications	
12.2	Wafer specifications	
13	APPLICATION INFORMATION	
13.1	Protection against visible light	
13.2	Protection against UV light	
13.3	Resistance to X-rays	
13.4	Characterisation of inlet and label	
13.5	Final test of the inlet and label	
13.6	Coil specification	
		<b>DELIVERY</b>
		14.1 Configuration of delivered ICs
		14.2 Packing
		14.3 Documentation
		14.3.1 Delivery documentation
		14.3.2 Fail-die identification
		14.3.3 Wafer mapping
		<b>REFERENCE DOCUMENTS</b>
		<b>DATA SHEET STATUS</b>
		<b>DEFINITIONS</b>
		<b>DISCLAIMERS</b>

## I-CODE1 Label IC (97 pF)

SL11CS3101

**1 FEATURES**

- Operating frequency of 13.56 MHz
- 512-bit read/write memory
- Operating range up to 1.5 m with Electronic Article Surveillance (EAS) detection and up to 1.2 m for memory read and write
- Anticollision: simultaneous operation of several labels
- Reliable EAS detection avoids false alarms
- Data retention of 10 years
- Operating temperature from -25 to +70 °C
- In accordance with standards of the Federal Communications Commission (FCC 15 part 3) and European Telecommunications Standards Institute (ETSI EN 300 330 and EN 300 683)
- Open communication protocol
- Application identifier saves time.

**2 APPLICATIONS**

- I-CODE<sup>(1)</sup> system labels.

(1) I-CODE - is a trademark of Koninklijke Philips Electronics N.V.

**4 ORDERING INFORMATION**

TYPE NUMBER	PACKAGE		
	NAME	DESCRIPTION	VERSION
SL11CS3101U	wafer	unsawn wafer; 150 µm; inked and mapped	-
SL11CS3101W	wafer	sawn wafer on foil (FFC); 150 µm; inked and mapped	-

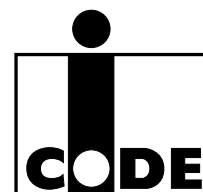
**3 GENERAL DESCRIPTION**

The I-CODE1 label IC is a dedicated chip for intelligent label applications for logistics and retail (including EAS) and for baggage and parcel identification in airline business and mail services.

The I-CODE system offers the possibility of operating labels simultaneously in the field of the reader antenna (anticollision). It is designed for long range applications.

Whenever connected to a very simple and cheap type of antenna (due to the 13.56 MHz carrier frequency) made out of a few windings printed, wound, etched or punched coil, the SL11CS3101 operates without line of sight up to a distance of 1.5 m (gate width).

I-CODE1 Label IC (97 pF)

SL1ICS3101

5 BLOCK DIAGRAM

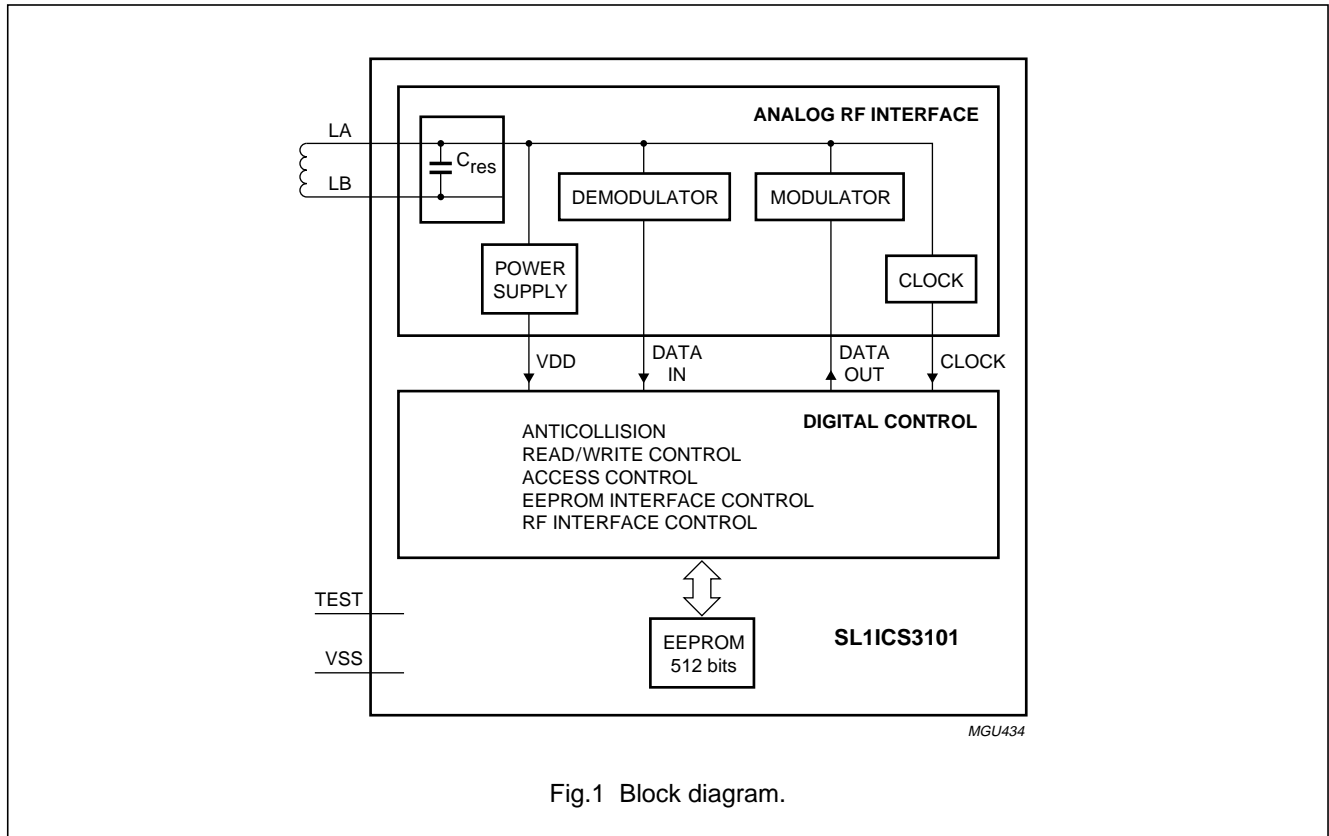

6 PINNING

SYMBOL	DESCRIPTION
LA	bond pad for antenna coil connection A
LB	bond pad for antenna coil connection B
TEST	test pad; this test pad is electrically neutral at sawn wafers
VSS	electrical connection of the substrate pad; the pad is electrically neutral at sawn wafers

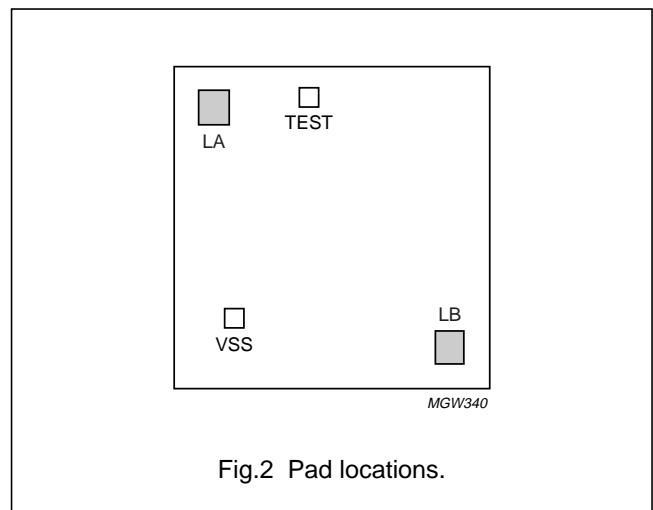

## I-CODE1 Label IC (97 pF)

## SL11CS3101

**7 FUNCTIONAL DESCRIPTION**

This specification describes the electrical, physical and dimensional properties of unsawn and sawn wafers on Film Frame Carrier (FFC) of the SL11CS3101 on a Philips 6C15 IDFW process and is the base for delivery of tested label ICs.

General recommendations are given for storage, handling, and processing of wafers and for the assembly of labels.

This product specification is valid for VCOL1V0 from mask revision NK:O and MB:B.

**7.1 General**

The label requires no internal power supply (see Fig.1). Its contactless interface generates the power supply and the system clock via the resonant circuitry by inductive coupling to the reader.

The interface also demodulates data which is transmitted from the reader to the label IC, and modulates the electromagnetic field for data transmission from the label IC to the reader.

Data is stored in a non-volatile memory (EEPROM).

**7.2 Memory organization**

The EEPROM has a memory capacity of 512 bits and is organised in 16 blocks consisting of 4 bytes each (see Table 1).

A block is the smallest access unit. Each block consists of 4 bytes (1 block = 32 bits).

Bit 0 in each byte represents the Least Significant Bit (LSB) and bit 7 the Most Significant Bit (MSB), respectively.

The higher 12 blocks contain user data and the lowest 4 blocks contain the serial number, the write access conditions and some configuration bits.

The values (in hexadecimal notation) are stored in the EEPROM after the wafer production process. The contents of blocks marked with 'X' in Table 1 are not defined at delivery.

**Table 1** EEPROM memory organization

BLOCK NUMBER	BYTE 0	BYTE 1	BYTE 2	BYTE 3	FUNCTION
0	SNR0	SNR1	SNR2	SNR3	serial number (lower bytes)
1	SNR4	SNR5	SNR6	SNR7	serial number (higher bytes)
2	F0	FF	FF	FF	write access conditions
3	X	X	X	X	special functions (EAS and QUIET)
4	X	X	X	X	family code, application identifier and user data
5	X	X	X	X	user data
6	X	X	X	X	user data
7	X	X	X	X	user data
8	X	X	X	X	user data
9	X	X	X	X	user data
10	X	X	X	X	user data
11	X	X	X	X	user data
12	X	X	X	X	user data
13	X	X	X	X	user data
14	X	X	X	X	user data
15	X	X	X	X	user data

I-CODE1 Label IC (97 pF)

SL11CS3101

7.2.1 SERIAL NUMBER

The unique 64-bit serial number is stored in blocks 0 and 1 and is programmed during the production process. Byte SNR0 in the table represents the least significant byte and byte SNR7 the most significant byte, respectively.

**Table 2** Block 0 with serial number (lower bytes)

	BYTE 0				BYTE 1				BYTE 2				BYTE 3						
	MSB		LSB		MSB		LSB		MSB		LSB		MSB		LSB				
Block 0	X	X	X	X	X	X	X	X	X	X	X	X	X	X	X	X	X	X	X
Name	SNR0				SNR1				SNR2				SNR3						

**Table 3** Block 1 with serial number (higher bytes)

	BYTE 0				BYTE 1				BYTE 2				BYTE 3						
	MSB		LSB		MSB		LSB		MSB		LSB		MSB		LSB				
Block 1	X	X	X	X	X	X	X	X	X	X	X	X	X	X	X	X	X	X	X
Name	SNR4				SNR5				SNR6				SNR7						

7.2.2 WRITE ACCESS CONDITIONS

The write access conditions in block 2 determine the write access for each of the 16 blocks. These bits can only be set to logic 0 (and never be changed to logic 1): therefore, already write protected blocks can never be written to from this moment on. This is also true for block 2. If this block is set into the write protected state by clearing of bits 5 and 4 at byte 0, no further changes in write access conditions are possible.

The 'ones' (11) in the 16 pairs of bits have to be cleared together if the corresponding block is wanted to be write protected forever: (11) for write access enabled and (00) write access disabled. Writing of bit pairs (10) or (01) to block 2 is not allowed.

**Remarks:** It is extremely important to be particularly careful when clearing the write access bits in block 2, as you can lose write access to all of the blocks in case of a mistake. Of course, this feature can be used to put the SL11CS3101 into a hardware write protected state.

**Table 4** Block 2 with write access conditions for all blocks

	BYTE 0				BYTE 1				BYTE 2				BYTE 3																			
	MSB		LSB		MSB		LSB		MSB		LSB		MSB		LSB																	
Block 2	1	1	1	1	0	0	0	0	1	1	1	1	1	1	1	1	1	1	1													
Write access for block number	3		2		1		0		7		6		5		4		11		10		9		8		15		14		13		12	

I-CODE1 Label IC (97 pF)

SL1ICS3101

7.2.3 SPECIAL FUNCTIONS

The special functions block 3 (see Table 5) holds the two bits E (EAS mode) and two bits Q (QUIET mode). The remaining 28 bits (marked X) are reserved for future use.

If the electronic article surveillance mode is active (bits EE = 11), then the label answers at an EAS command.

If the QUIET mode is enabled (setting bits QQ = 11), then the label is permanently disabled but can be activated again with the command RESET QUIET BIT. The label can be activated also by disabling the QUIET mode by setting bits QQ = 00. The state of the QUIET mode does not influence the functionality of the EAS command.

Writing of bit pairs 10 or 01 to block 3 is not allowed.

**Remarks:** Changing of the write access control or configuration must be done in a secure environment by reading the current value of the block and masking in the new values for bit positions that may be changed. The label must not be moved out of the communication field of the antenna during writing! We recommend to put the label close to the antenna and not to remove it during operation.

**Table 5** Block 3 with special functions

	BYTE 0				BYTE 1				BYTE 2				BYTE 3											
	MSB		LSB		MSB		LSB		MSB		LSB		MSB		LSB									
Block 3	X	X	X	X	Q	Q	E	E	X	X	X	X	X	X	X	X	X	X	X	X	X	X	X	X
Name	not used		QUIET		EAS		not used				not used				not used									

7.2.4 FAMILY CODE AND APPLICATION IDENTIFIER

The I-CODE system offers the feature to use (independently) family codes and/or application identifiers with some reader commands. This allows for example the creation of 'label families'.

These two 8-bit values are located at the beginning of block 4 and are only evaluated if the bytes at the reader commands are unequal to zero.

Only if both corresponding parameter bytes at the reader commands ANTICOLLISION/SELECT, EAS and UNSELECTED READ respectively, are set to logic 0, then block 4 can be used for user data without restriction.

Bytes 2 and 3 are for customer usage.

**Table 6** Block 4 with family code and application ID

	BYTE 0				BYTE 1				BYTE 2				BYTE 3											
	MSB		LSB		MSB		LSB		MSB		LSB		MSB		LSB									
Block 4	X	X	X	X	X	X	X	X	X	X	X	X	X	X	X	X	X	X	X	X	X	X	X	X
Name	family code				application ID				user data				user data											

7.2.5 USER DATA

The remaining blocks 5 to 15 are for customer usage.

## I-CODE1 Label IC (97 pF)

## SL11CS3101

**8 LIMITING VALUES**

In accordance with the Absolute Maximum Rating System (IEC 60134); notes 1 and 2.

SYMBOL	PARAMETER	CONDITIONS	MIN.	TYP.	MAX.	UNIT
$T_{stg}$	storage temperature		-55	–	+140	°C
$T_j$	junction temperature		-55	–	+140	°C
$V_{esd}$	electrostatic discharge voltage	note 3	-2	–	+2	kV
$I_{i(LA-LB)(p)}$	input current (peak value)	note 4	-80	–	+80	mA

**Notes**

- Stresses above those listed in this table may cause permanent damage to the device. This is a stress rating only and functional operation of the device at these or any conditions other than those described in Chapter 11 is not implied.
- This product includes circuitry specifically designed for the protection of its internal devices from the damaging effects of excessive static charge. Nonetheless, it is suggested that conventional precautions be taken to avoid applying greater than the rated maxima.
- Human Body Model (HBM) in accordance with “MIL-STD-883D Method 3015.7”.
- At 13.56 MHz including current via resonant capacitor.

**9 QUALITY ASSURANCE****9.1 Electrical acceptance test**

The electrical acceptance test is performed in line ('sampling on the fly') according to the test specifications.

Sampling plan:

- According to document “General quality specification”.

**9.2 Visual inspection****9.2.1 AFTER WAFER FINAL TEST**

Performed according to document “SNW-FQ-627”.

Sampling plan:

- According to document “General quality specification”.

**9.2.2 AFTER SAWING (FILM FRAME CARRIER)**

Performed according to document “PICTOH-QS007”.

Sampling plan (3 wafers per lot):

- Accept 0 to 3.

**10 HANDLING INSTRUCTIONS**

Please refer to Philips “General specification for 6” wafer” for the following items:

- Sawing
- Die attach
- Wire bonding.



## I-CODE1 Label IC (97 pF)

## SL11CS3101

**11 ELECTRICAL CHARACTERISTICS**

$T_{amb} = -25$  to  $+70$  °C; unless otherwise specified.

SYMBOL	PARAMETER	CONDITIONS	MIN.	TYP. <sup>(1)</sup>	MAX.	UNIT
<b>General</b>						
$T_{amb}$	ambient temperature		-25	–	+70	°C
$T_j$	junction temperature		-25	–	+85	°C
<b>Supply</b>						
$P_{min}$	minimum operating power	$V_{LA-LB} = 2$ V (RMS); note 2	–	450	–	μW
<b>Inputs</b>						
$C_{res}$	capacitance between pads LA and LB	$V_{LA-LB} = 2$ V (RMS); note 3	92	97	102	pF
$R_{mod}$	modulator-on resistance		50	115	250	Ω
$I_{i(LA-LB)(rms)}$	input current (RMS value)	note 4	–	–	50	mA
$ V_{i(LA-LB)(p)} $	minimum input voltage (peak value)	standard mode; note 5 read and EAS	–	3.1	3.7	V
		write	–	3.6	4.1	V
		fast mode; note 5; read, EAS and write	–	5.2	6.5	V
<b>Modulation</b>						
$m_{min}$	minimum modulation index of RF voltage for demodulator response	note 6	–	10	14	%
$m_{max}$	maximum modulation index of RF voltage for demodulator response	note 6	30	–	–	%
<b>Timing</b>						
$f_{oper}$	operating frequency	note 7	13.553	13.560	13.567	MHz
$t_{PW}$	modulation start-pulse length of RF voltage	$m \geq 10\%$ ; note 8 standard mode	3.54	5.31 <sup>(9)</sup>	9.44	μs
		fast mode	15.34	17.11 <sup>(9)</sup>	20.06	μs
$t_D$	demodulator response time	$m \geq 10\%$	0.1	0.8	2.4	μs
<b>EEPROM</b>						
$t_{ret}$	EEPROM data retention time	$T_{amb} \leq 55$ °C	10	–	–	years
$n_{write}$	EEPROM write endurance		100000	–	–	cycles

**Notes**

1. Typical ratings are not guaranteed. These values listed are at  $T_{amb} = 25$  °C.
2. Including losses in resonant capacitor and rectifier.
3. Measured with an HP4285A LCR meter at 13.56 MHz.
4. Including current via resonant capacitor.
5. The voltage between pads LA and LB is limited by the on-chip voltage limitation circuitry, corresponding to parameter  $I_{i(LA-LB)}$ .

## I-CODE1 Label IC (97 pF)

SL11CS3101

6. Definition:  $m = \frac{V_{\max} - V_{\min}}{V_{\max} + V_{\min}}$
7. Bandwidth limitation ( $\pm 7$  kHz) according to ISM band regulations.
8. The given values are derived from the 13.56 MHz system frequency.
9. Recommended values for pulse duration generated at the read/write device.

**12 MECHANICAL CHARACTERISTICS****12.1 Die specifications**

PARAMETER	VALUE
Designation	VCOL1V0; visible on each die (see Fig.3)
Bond pad location	see Fig.3
Bond pad size: LA and LB	130 × 150 μm
Test pad size: TEST and VSS	90 × 90 μm
Bond pad metallization material	AlSiCu
Metallization thickness	1.4 μm
Die dimensions (including 80 μm scribe line)	1460 × 1490 μm
Die dimensions (excluding scribe line)	1380 × 1410 μm
Tolerances for sawn dies	25 μm
Pad identification	see Fig.2
Top side passivation material	oxynitride; notes 1 and 2
Passivation thickness	1.6 μm

**Notes**

- The passivation is a protection of active areas against dust (particles), humidity, and general contamination (whole surface of the chip except for the bond pads).
- Due to the glass-like physical properties careful handling and processing is required.

I-CODE1 Label IC (97 pF)

SL11CS3101

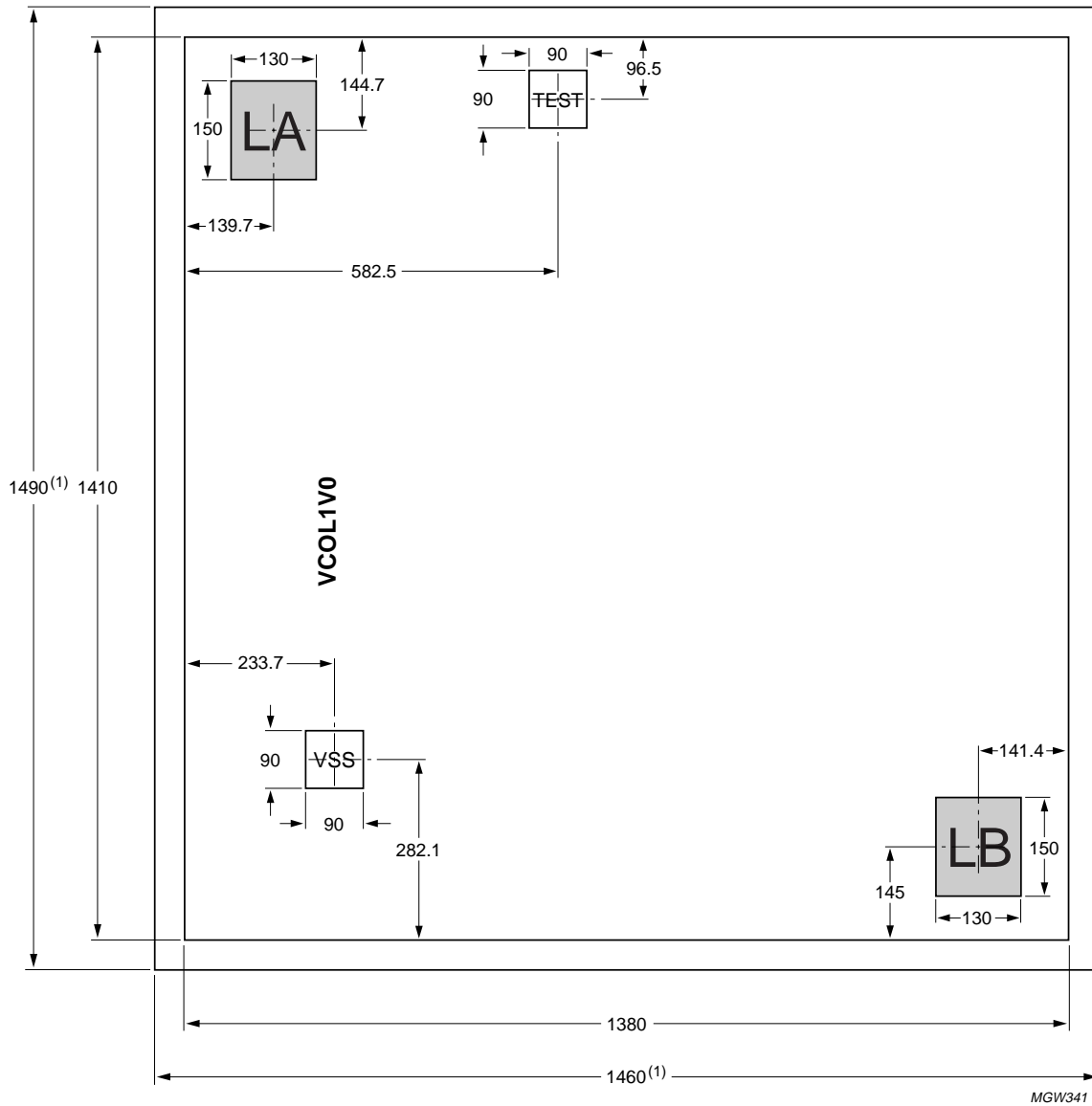

Dimensions in  $\mu\text{m}$ .  
(1) Including  $80 \mu\text{m}$  scribe line.

Fig.3 Die dimensions.

## I-CODE1 Label IC (97 pF)

SL11CS3101

**12.2 Wafer specifications**

For further information, please refer to the Philips documents: *“Dicing process for thin wafers”* and *“General specification for 6” wafer”*. In case of doubt or inconsistency the mentioned wafer specifications are applicable.

PARAMETER	VALUE
Designation	each wafer is laser scribed with batch and wafer number
Wafer diameter	150 ± 0.3 mm (150 mm = 6")
Die separation lane width	80 µm (scribe line)
Electrical connection of substrate	VSS potential
Geometrically complete dies per wafer	approximately 7400
Orientation of dies relatively to wafer flat	see Fig.5
Position of test structures	see Fig.5
Wafer layout	see Fig.5
Batch size	24 wafers
Process	6C15 IDFW
Backside treatment	note 1
Wafer status	note 2

**Notes**

1. Wafers can be delivered with a thickness of 525 µm (untreated) or with 150 ± 15 µm (approximately 6 mil) ground and etched backside.
2. There are two wafer status: unsawn and sawn on FCC; both tested. Minimum yield per lot is 30%.

I-CODE1 Label IC (97 pF)

SL11CS3101

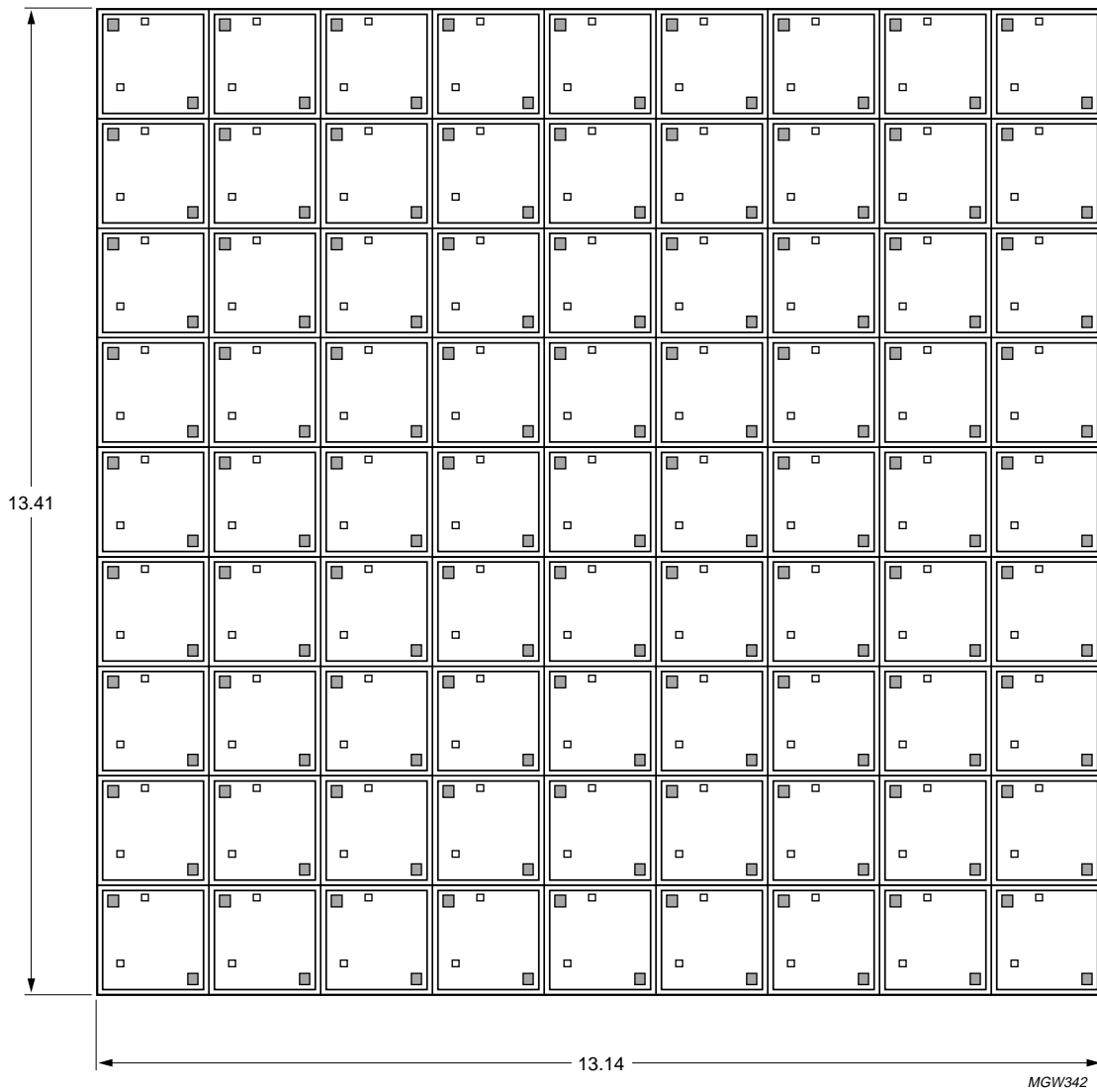

Dimensions in mm.

Fig.4 Cluster plan.

I-CODE1 Label IC (97 pF)

SL11CS3101

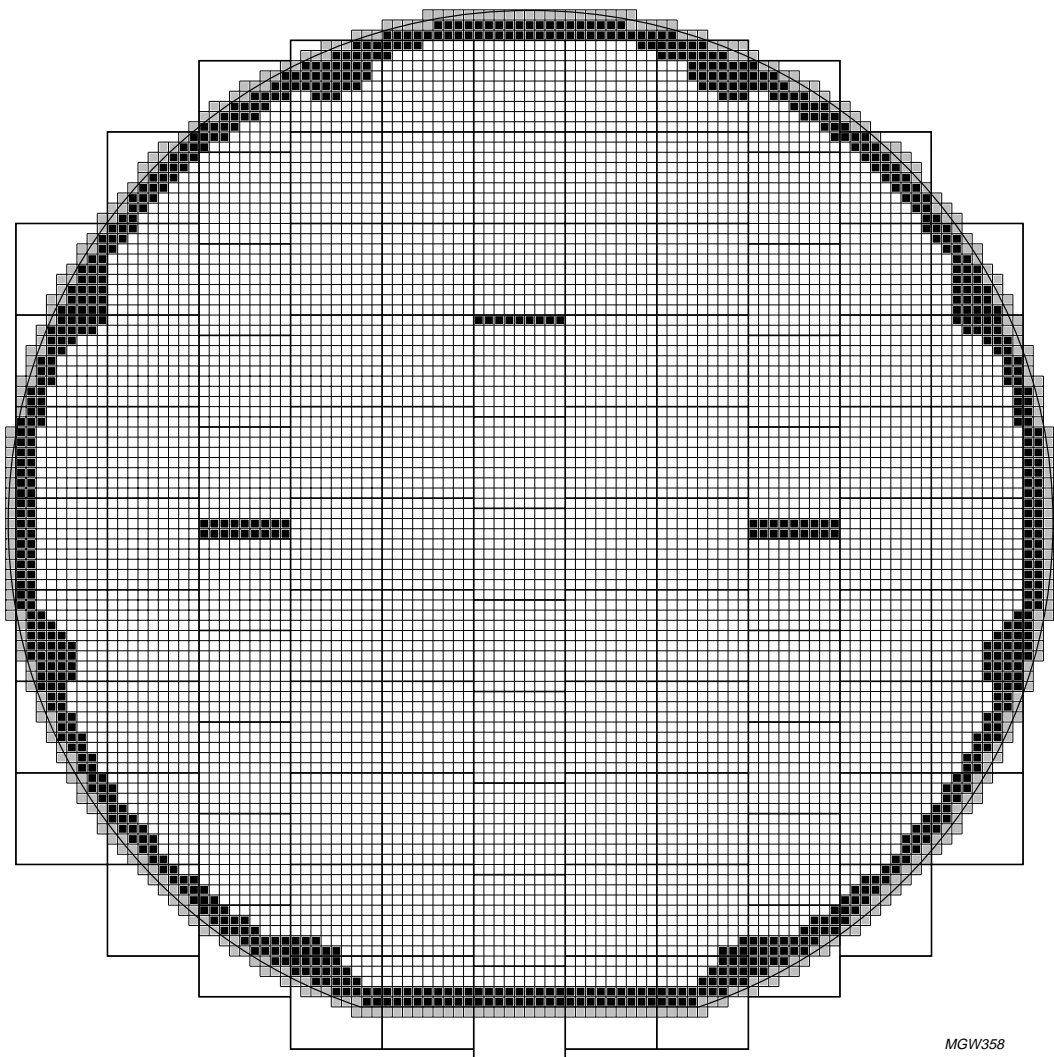

MGW358

Dimensions in mm.  
The three black areas show the position of the Process Control Module (PCM) structures on the 6 inch wafer.

Fig.5 Cluster map.

## I-CODE1 Label IC (97 pF)

## SL11CS3101

**13 APPLICATION INFORMATION****13.1 Protection against visible light**

As a result of the ultra low power design of the SL11CS3101 some analog circuits on the chip are light sensitive. This means that common sunlight can impact the operation of the label if the chip is not protected against visible light radiation.

Measurements have shown that a maximum radiation of  $E = 60 \text{ W/m}^2$  (spectrum: 400 to 1000 nm) causes a reduced operating range of the plain chip.

Measurements of direct sunlight in summer deliver values up to  $260 \text{ W/m}^2$ .

To ensure proper operation an expected minimum radiation reduction factor of approximately  $2 \times \frac{260}{60} = 8.7$

(round 9) must be provided by the encapsulation. That means special care has to be taken to ensure a sufficient light protection of the SL11CS3101 (e.g. non translucent encapsulation or underfiller) according to application requirements.

**13.2 Protection against UV light**

An EEPROM memory, as used in the SL11CS3001, has some principle sensitivity to UV light (applies to EEPROM technology in general).

Thus strong UV light exposure in the production of inlets or labels has to be avoided. UV light protection has to be ensured using appropriate assembly methods.

**13.3 Resistance to X-rays**

X-ray exposure on comparable Philips ICs (with even smaller feature size) caused neither a long term influence on the behaviour of the ICs nor on the data retention of the EEPROMs.

**13.4 Characterisation of inlet and label**

The parameters recommended to be characterised for the inlet and label are given in Table 7.

For more detailed information on inlet and label characterization, please refer to Philips application note "*I-CODE1 Label IC, Coil Design Guide*"

**13.5 Final test of the inlet and label**

Basic flow for production and test:

- Production of wafer
- Testing of dies on wafer
- Writing of serial numbers and pre-configuration
- Sawing of wafer
- Assembly of inlets and labels
- Final test of inlets and labels
- Writing of customer data.

To detect damage of EEPROM cells during production of inlets and labels a final test of the EEPROM after assembly of the inlet or label is recommended. This is necessary to achieve lowest failure rates.

**13.6 Coil specification**

The SL11CS3101 has to be connected at pads LA and LB to a coil characterised by its electrical parameters according to Philips application note "*I-CODE1 Label IC, Coil Design Guide*".

**Table 7** Inlet and label parameters

SYMBOL	PARAMETER	CONDITIONS
$f_{\text{res}}$	resonant frequency	at $T_{\text{amb}} = 22 \text{ °C}$ and $H_{\text{TH}}$ ; note 1
$H_{\text{TH}}$	threshold value for the field strength for command UNSELECTED READ (standard mode)	command UNSELECTED READ is OK
$H_{\text{WR}}$	threshold value for the field strength for command WRITE (standard mode)	command WRITE (and verifying read) is OK

**Note**

1. If no command is transmitted to the inlet or label, then the label generates no response and there is no modulation.

---

## I-CODE1 Label IC (97 pF)

## SL1ICS3101

---

### 14 DELIVERY

#### 14.1 Configuration of delivered ICs

The SL1ICS3101 is delivered with the following configuration by Philips:

- Serial number is unique and read only
- Write access conditions allow to change all blocks (with the exception of both serial number blocks)
- Status of the EAS mode is not defined
- Status of the QUIET mode is not defined
- Family code and application identifier are not defined
- User data memory is not defined.

**Remark:** As the status of the QUIET mode is not defined at delivery, the first command to be executed on the SL1ICS3101 should be the command RESET QUIET BIT.

#### 14.2 Packing

The packing for shipment of wafers has to protect the wafers against shock, severe impact, dust and electrostatic discharge. The packing of unsawn wafers or sawn wafers is done according to Philips "*General Specification for 6" wafer*".

#### 14.3 Documentation

##### 14.3.1 DELIVERY DOCUMENTATION

Each wafer container and each larger shipment container is individually marked with the identification information as follows.

- Diffusion batch number (wafer lot number)
- Part designation (type) with revision number
- Ordering code
- Date code of lot acceptance
- Good die quantity.

The print out of the final test results is attached to the packing and contains the good die quantity related to every wafer number.

##### 14.3.2 FAIL-DIE IDENTIFICATION

Every die is electrically tested according to the data sheet. Identification of the chips which do not confirm with the electrical parameters of the data sheet is done by inking and/or wafer mapping (all dies at wafer periphery are identified by 'FAIL').

##### 14.3.3 WAFER MAPPING

Wafer mapping for failed die identification is available on floppy-disk (format 3.5", Electroglas ESC-ASCEND).

**Remark:** The wafer map refers to unsawn wafers. At sawn wafers (on FFC) additional ICs might be inked (marked as 'FAIL') if damaged during the sawing process (compared to wafer map).

See Fig.6 for an example of the screen shot of a wafer map.



I-CODE1 Label IC (97 pF)

SL11CS3101

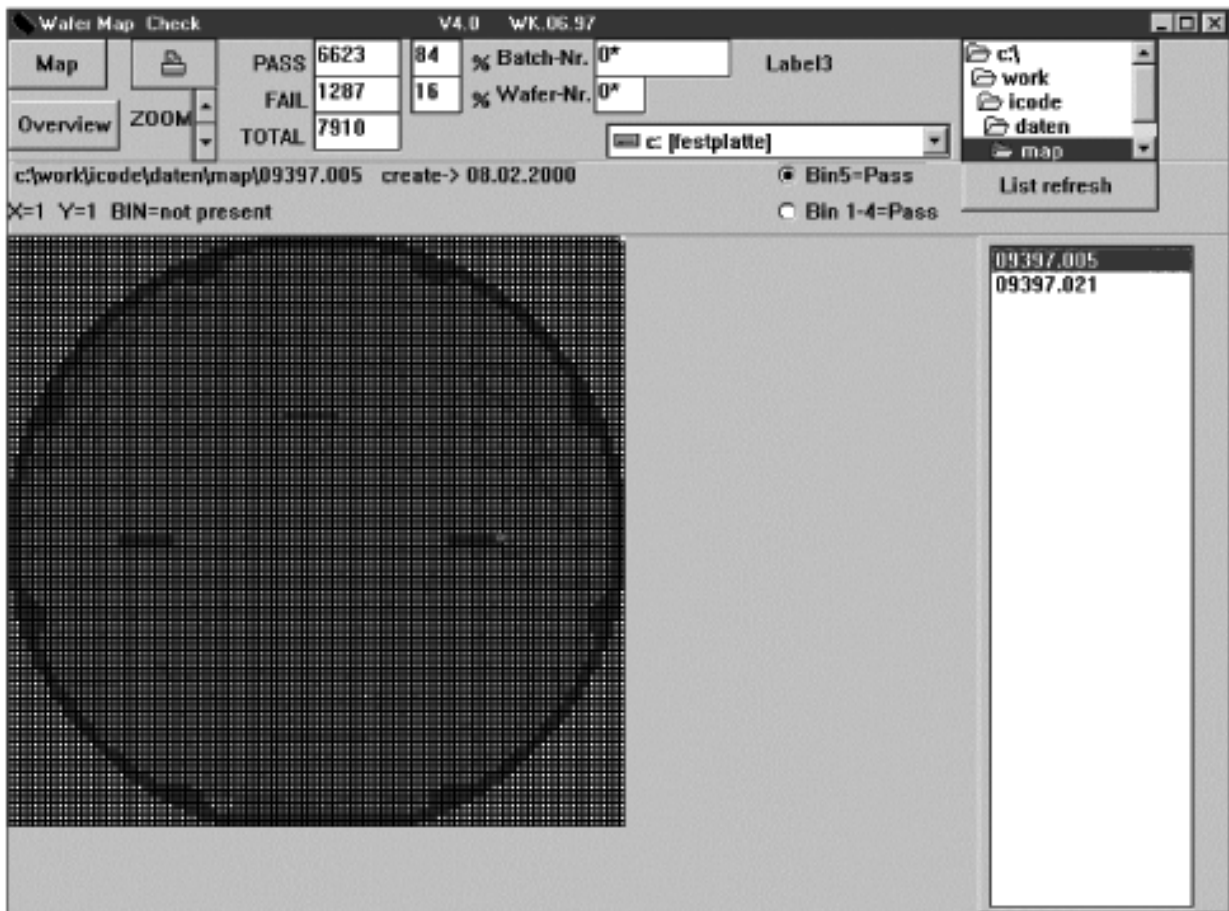

MGW359

Fig.6 Screen shot of wafer map.

I-CODE1 Label IC (97 pF)

SL11CS3101

**Table 8** Map file of this example

ELECTROGLAS APPLICATIONS - WAFER TEST DATA						
FILE				:		
COPYRIGHT				:		
ASCEND				:	### shortening of the file ###	
LOT	09397			:	3	0
DEVICE	VCOL1HE2			:	X40Y3	5 1
PRODUCT	VCOL\4020			:	X41Y3	5 1
WAFER	05			:	X42Y3	5 1
READER	09397-05-B6			:	X43Y3	5 1
XSTEP	575	UNITS	(0.1)MIL	:	X44Y3	5 1
YSTEP	587	UNITS	(0.1)MIL	:	X45Y3	5 1
XREF	16891	UNITS	(0.1)MIL	:	X46Y3	5 1
YREF	-261	UNITS	(0.1)MIL	:	X47Y3	2 0
XDELTA	0			:	X48Y3	2 0
YDELTA	0			:	X49Y3	2 0
FLAT	0			:	X50Y3	5 1
XFRST	21			:	X51Y3	5 1
YFRST	50			:	X52Y3	5 1
PRQUAD	1			:	X53Y3	5 1
COQUAD	1			:	X54Y3	5 1
DIAM	6000	UNITS	MIL	:		
DATE	2000-01-23			:		
TIME	15:30:00			:	### shortening of the file ###	
OPERATOR		4020		:		
SET-UP FILE	M:\SET\VCOL1HE2.SET			:		
TEST SYSTEM	SYS	VCOL\4020		:	EDATE	
TEST DATA				:	ETIME	
PROBE CARD	PC			:		
PROBER	PIWP105			:		

**15 REFERENCE DOCUMENTS**

CATEGORY	NUMBER OR TITLE
Standard	"MIL-STD 883D Method 3023"
Standard	"MIL-STD-883D Method 3015.7"
MISD standard	"SNW-FQ-627"
	"PICTOH-QS007"
MISD standard	"General quality specification"
Data sheet	"General Specification for 6" Wafer"
Application note	"I-CODE1 Label IC, Coil Design Guide"
Application note	"Dicing process for thin wafers"

## I-CODE1 Label IC (97 pF)

SL11CS3101

## 16 DATA SHEET STATUS

DATA SHEET STATUS <sup>(1)</sup>	PRODUCT STATUS <sup>(2)</sup>	DEFINITIONS
Objective data	Development	This data sheet contains data from the objective specification for product development. Philips Semiconductors reserves the right to change the specification in any manner without notice.
Preliminary data	Qualification	This data sheet contains data from the preliminary specification. Supplementary data will be published at a later date. Philips Semiconductors reserves the right to change the specification without notice, in order to improve the design and supply the best possible product.
Product data	Production	This data sheet contains data from the product specification. Philips Semiconductors reserves the right to make changes at any time in order to improve the design, manufacturing and supply. Changes will be communicated according to the Customer Product/Process Change Notification (CPCN) procedure SNW-SQ-650A.

## Notes

1. Please consult the most recently issued data sheet before initiating or completing a design.
2. The product status of the device(s) described in this data sheet may have changed since this data sheet was published. The latest information is available on the Internet at URL <http://www.semiconductors.philips.com>.

## 17 DEFINITIONS

**Short-form specification** — The data in a short-form specification is extracted from a full data sheet with the same type number and title. For detailed information see the relevant data sheet or data handbook.

**Limiting values definition** — Limiting values given are in accordance with the Absolute Maximum Rating System (IEC 60134). Stress above one or more of the limiting values may cause permanent damage to the device.

These are stress ratings only and operation of the device at these or at any other conditions above those given in the Characteristics sections of the specification is not implied. Exposure to limiting values for extended periods may affect device reliability.

**Application information** — Applications that are described herein for any of these products are for illustrative purposes only. Philips Semiconductors make no representation or warranty that such applications will be suitable for the specified use without further testing or modification.

## 18 DISCLAIMERS

**Life support applications** — These products are not designed for use in life support appliances, devices, or systems where malfunction of these products can reasonably be expected to result in personal injury. Philips Semiconductors customers using or selling these products for use in such applications do so at their own risk and agree to fully indemnify Philips Semiconductors for any damages resulting from such application.

**Right to make changes** — Philips Semiconductors reserves the right to make changes, without notice, in the products, including circuits, standard cells, and/or software, described or contained herein in order to improve design and/or performance. Philips Semiconductors assumes no responsibility or liability for the use of any of these products, conveys no licence or title under any patent, copyright, or mask work right to these products, and makes no representations or warranties that these products are free from patent, copyright, or mask work right infringement, unless otherwise specified.

# ***Philips Semiconductors – a worldwide company***

## **Contact information**

For additional information please visit <http://www.semiconductors.philips.com>. Fax: +31 40 27 24825

For sales offices addresses send e-mail to: [sales.addresses@www.semiconductors.philips.com](mailto:sales.addresses@www.semiconductors.philips.com).

© Koninklijke Philips Electronics N.V. 2002

SCA74

All rights are reserved. Reproduction in whole or in part is prohibited without the prior written consent of the copyright owner.

The information presented in this document does not form part of any quotation or contract, is believed to be accurate and reliable and may be changed without notice. No liability will be accepted by the publisher for any consequence of its use. Publication thereof does not convey nor imply any license under patent- or other industrial or intellectual property rights.

Printed in The Netherlands

613502/02/pp20

Date of release: 2002 May 23

Document order number: 9397 750 08397

*Let's make things better.*

**Philips  
Semiconductors**



**PHILIPS**

This datasheet has been download from:

[www.datasheetcatalog.com](http://www.datasheetcatalog.com)

Datasheets for electronics components.